

FPC

PRESSURE FILTERS



MATERIALS

Head: Cast iron
Bowl: Steel
Bypass valve: Steel
Seals: NBR Nitrile
(FKM - on request fluoroelastomer)
Indicator housing: Brass

PRESSURE

Max working: 38,5 MPa (385 bar)
Collapse, differential for the filter element (ISO 2941):
series standard 2 MPa (20 bar)

BYPASS VALVE

Setting:
600 kPa (6 bar) \pm 10%
350 kPa (3,5 bar)

WORKING TEMPERATURE

From -25° to +125° C

COMPATIBILITY (ISO 2943)

Full with fluids: HH-HL-HM-HV-HTG
(according to ISO 6743/4)
For fluids different than the above mentioned,
please contact our Customer Service.



HYDRAULIC DIAGRAM

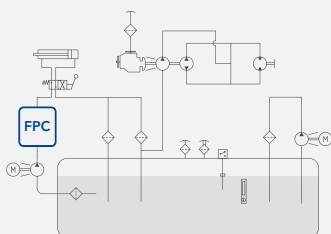

Is this datasheet the latest release? Please check on our website.

ORDERING AND OPTION CHART

F	P	C	COMPLETE FILTER FAMILY				FILTER ELEMENT FAMILY	E	P	C
			SIZE & LENGHT	51	53	55	SIZE & LENGHT			
			PORT TYPE							
			B = BSP thread	B	B	B				
			M = Metric thread (only M22x1,5)	M	M	M				
			S = SAE thread	S	S	S				
			PORT SIZE							
			04 = 1/2"	04	04	04				
			06 = 3/4"	06	06	06				
			08 = 1"	08	08	08				
			BYPASS VALVE							
			W = without	W	W	W				
			C = 600 kPa (6 bar)	C	C	C				
			D = 350 kPa (3,5 bar)	D	D	D				
			SEALS				SEALS			
			N = NBR Nitrile	N	N	N				
			F = FKM Fluoroelastomer	F	F	F				
			FILTER MEDIA				FILTER MEDIA			
			FA = fibreglass 5 µm(c) β>1.000 Δp 2MPa (20 bar)	FA	FA	FA				
			FB = fibreglass 7 µm(c) β>1.000 Δp 2MPa (20 bar)	FB	FB	FB				
			FC = fibreglass 12 µm(c) β>1.000 Δp 2MPa (20 bar)	FC	FC	FC				
			FS = fibreglass 16 µm(c) β>1.000 Δp 2MPa (20 bar)	FS	FS	FS				
			FD = fibreglass 21 µm(c) β>1.000 Δp 2MPa (20 bar)	FD	FD	FD				
			FE = fibreglass 30 µm(c) β>1.000 Δp 2MPa (20 bar)	FE	FE	FE				
			CLOGGING INDICATOR**							
			00 = without predisposition	00	00	00				
			03 = port, plugged	03	03	03				
			5E = visual differential 500 kPa (5 bar)	5E	5E	5E				
			6E = electrical differential 500 kPa (5 bar)	6E	6E	6E				
			7E = indicator 6E with LED	7E	7E	7E				
			XE = electrical differential N.O. 500 kPa (5 bar)	XE	XE	XE				
			XD = electrical differential N.O. 240 kPa (2,4 bar)	XD	XD	XD				
			XL = electrical differential N.C. 300 kPa (3 bar)	XL	XL	XL				
			XG = electrical differential N.C. 340 kPa (3,4 bar)	XG	XG	XG				
			T2 = elect. diff. 500 kPa (5 bar) with thermostat 30°C	T2	T2	T2				
			ACCESSORIES							
			W = without clogging indicator predisposition	W	W	W				
			A = lateral indicator port (see DWG)	A	A	A				
			C = indicator port on the top (see DWG)	C	C	C				
			ACCESSORIES							
			X = no accessory available	X	X	X				

SPARE PARTS ELEMENTS

FILTER HOUSING										FILTER ELEMENT			CLOGGING INDICATOR				
B	P	C								E	P	C					



SPARE SEAL KIT

	NBR	FKM
FPC5	521.0131.2	521.0132.2

**When the filter is ordered with FKM seals, the first digit of the indicator code is a letter
(please see Clogging Indicator Chapter for further details)

INSTALLATION DRAWING

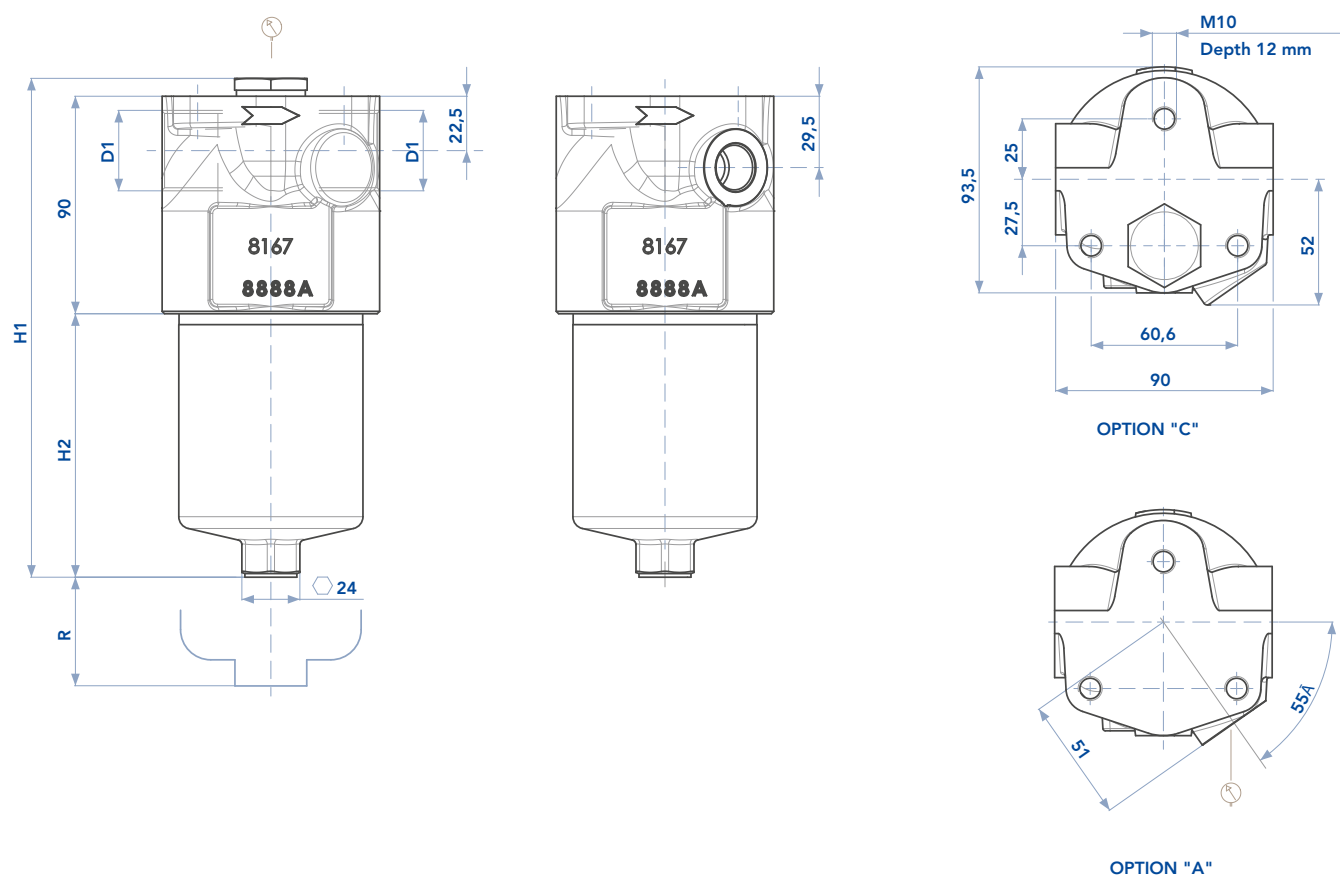

FILTER HOUSING

	D1	H1	H2	Kg
FPC51	M22x1,5 - 1/2" - 3/4" - 1" BSP or SAE thread	206,5	109,0	4,2
FPC53	M22x1,5 - 1/2" - 3/4" - 1" BSP or SAE thread	254,5	157,0	4,7
FPC55	M22x1,5 - 1/2" - 3/4" - 1" BSP or SAE thread	307,0	209,5	5,3

MAINTENANCE

The best time to change your filter element is just before it reaches its maximum dirt-holding capacity. For this reason, we recommend to monitor the pressure of the hydraulic oil flowing through the filter with a clogging indicator. When it is time to change the filter element, switch off the system before opening the filter housing and make sure there is no pressure in the filter. Unscrew the bowl and remove the dirty filter element. Replace it with an original UFI element, verifying the

part number on the filter label or on the catalogue. Clean the bowl; check the gaskets conditions and replace if necessary. Insert the clean element into his seat, handling with care and cleanliness. Screw the housing until it stops, with a tightening torque of 70 Nm +5/0. We recommend the stocking of a spare UFI filter element for timely replacement when required.

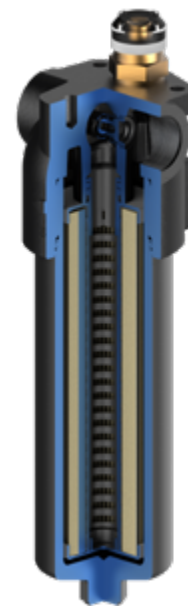

FILTER ELEMENT

	A	B	C	Kg	AREA (cm ²)
				Media F+	Media F+
EPC51	56,5	18	118	0,12	945
EPC53	56,5	18	166	0,15	1.401
EPC55	56,5	18	219	0,19	1.905

The used filter elements cannot be cleaned and are classified as “Dangerous waste material”. They must be disposed according to local laws by authorized Companies. Verify that the Company you choose has the expertise and authorization to dispose this type of waste material.

PRESSURE DROP CURVES (Δp)

The “Assembly Pressure Drop (Δp)” is obtained by adding the pressure drop values of the Filter Housing and of the Clean Filter Element corresponding to the considered Flow Rate and it must be

lower than 120 kPa (1,2 bar) and should never exceed 1/3 of the bypass valve setting.

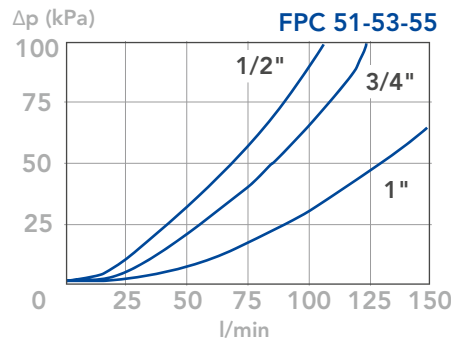

CLEAN FILTER ELEMENT PRESSURE DROP WITH F+ MEDIA
(depending both on the internal diameter of the element and on the filter media)

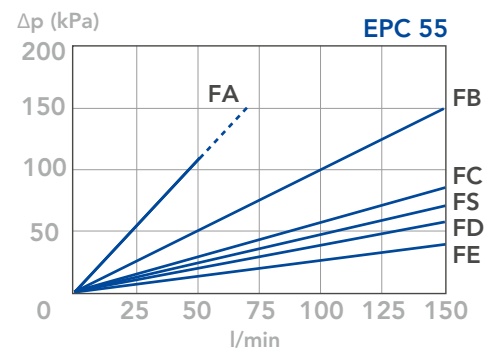
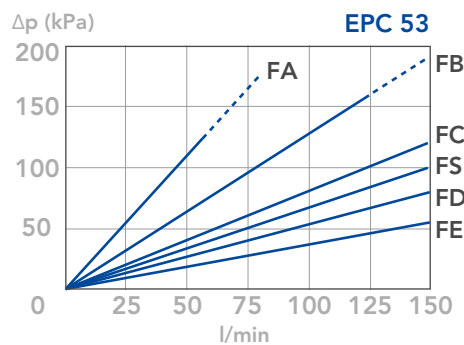
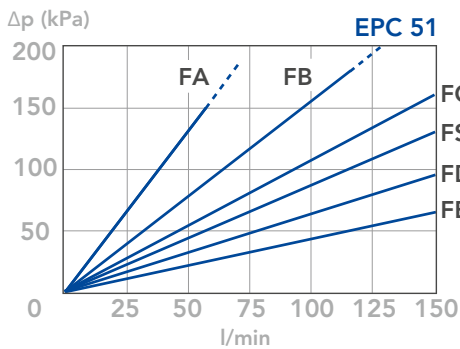

BYPASS VALVE PRESSURE DROP

When selecting the filter size, these curves must be taken into account if it is foreseen that any flow peak is to be absorbed by the bypass valve, it also must be of proper configuration to avoid pressure peaks. The valve pressure drop is directly proportional to fluid specific gravity.

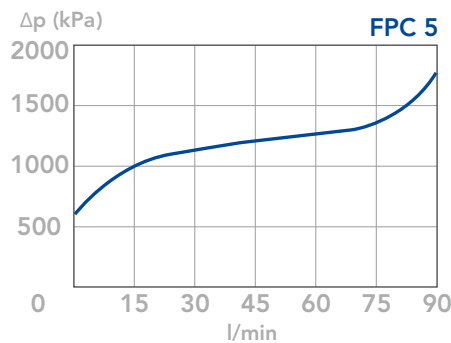

N.B.

All the curves have been obtained with mineral oil having a kinematic viscosity 30 cSt and specific gravity 0,86 Kg/dm³; for fluids with different features, please consider the factors described in the first part of this catalogue. All the curves

are obtained from test done at the UFI HYDRAULIC DIVISION Laboratory, according to the specification ISO 3968. In case of discrepancy, please check the contamination level, viscosity and features of the fluid in use.